

DIRECTIONS FOR USE TOASTER-OVEN-BROILER & PIZZA OVEN

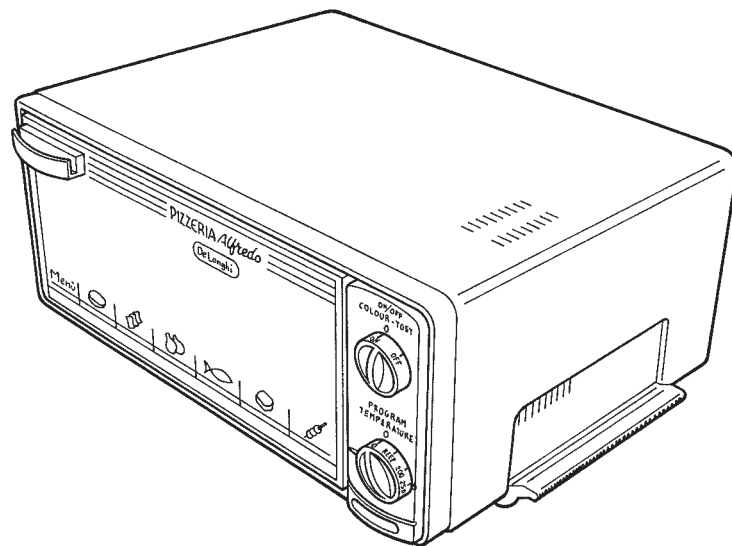

**Mod. XU15
XU15C**

De' Longhi products are the finest and most versatile products available. Please read this booklet carefully to ensure that you obtain the fullest benefit from your appliance.

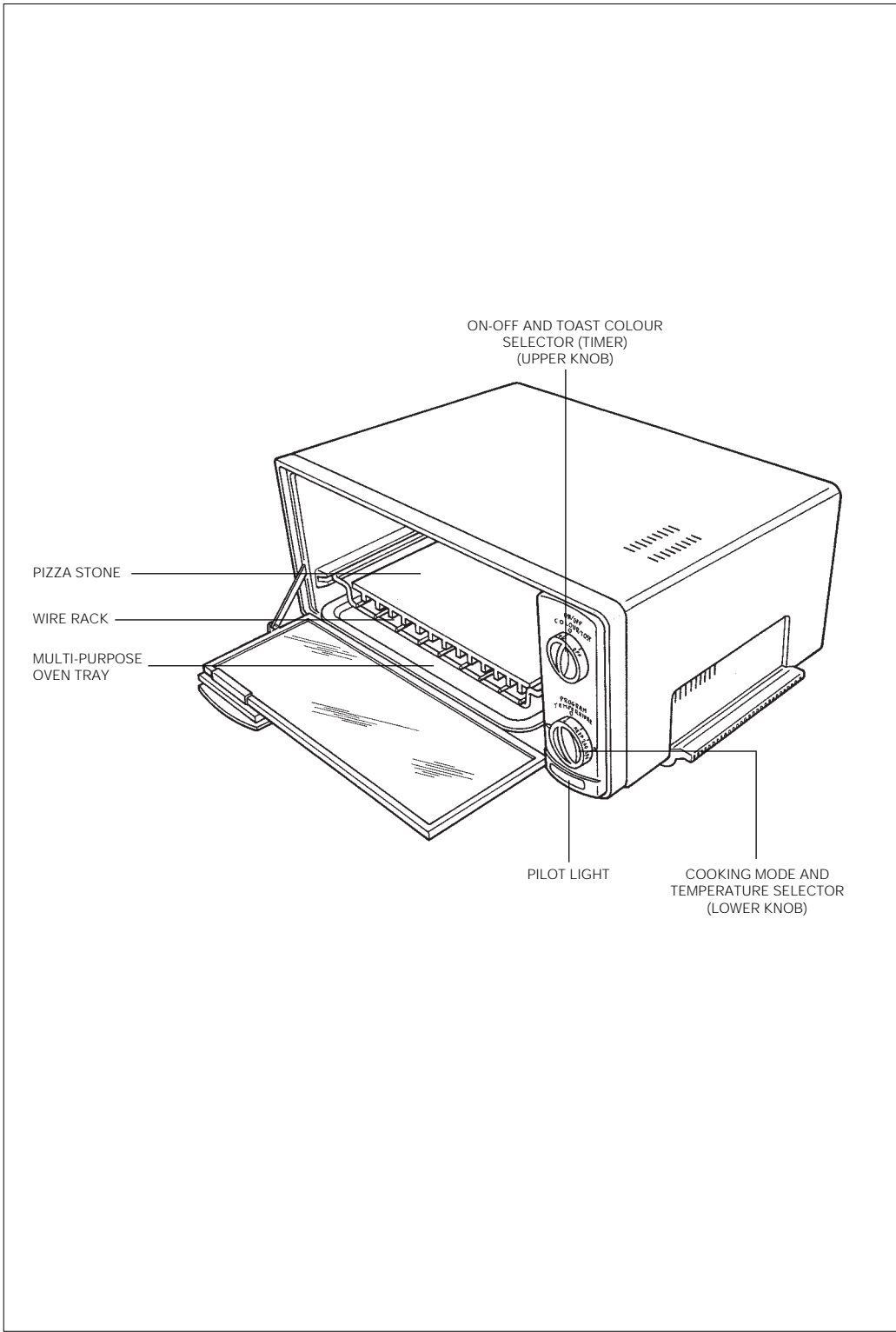

Cooking programmes

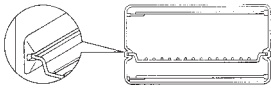
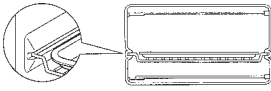
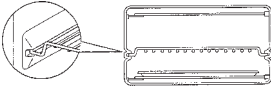
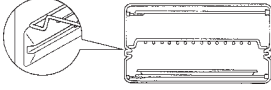
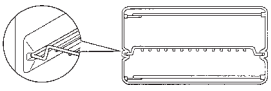
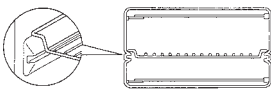
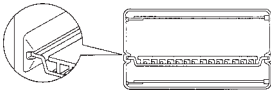
Program	Position of ON/OFF and toast colour selector	Position of cooking mode and temperature selector	Position of wire rack/ oven tray
Keep warm	ON	Keep warm	 1
Bake	ON	Up to 450°F	 2
Broil	ON	Broil	 3
			 4
Toast	Up to 7 minutes	Toast	 5
Sandwich	Up to 7 minutes	Toast	 6
Pizza *	ON	Pizza	 7

* When cooking pizza, the pizza stone should be placed on the wire rack.

IMPORTANT SAFEGUARDS

When using electrical appliances, basic safety precautions should always be followed, including the following:

1. Read all instructions.
2. Do not touch hot surfaces: Use handles or dials.
3. Before using this appliance, move it two to four inches away from the wall or any object on the counter top. Remove any object that may have been placed on top of the appliance. Do not use on surfaces where heat may cause a problem.
4. To protect against electrical shock, do not place unit in or under water. See instructions for cleaning.
5. Close supervision is necessary when any appliance is used by or near children.
6. Unplug from outlet when not in use and before cleaning. Always turn the unit OFF before unplugging. Allow to cool before putting on or taking off parts, and before cleaning the appliance.
7. Do not operate any appliance with a damaged cord or plug or after the appliance malfunctions, or has been damaged in any manner. Return appliance to the nearest authorized service facility for examination, repair or adjustment.
8. The use of accessory attachments not recommended by the appliance manufacturer may cause injuries.
9. Do not use outdoors.
10. Do not let cord hang over edge of table or counter, or touch hot surfaces.
11. Do not place on or near a hot gas or electric burner.
12. Extreme caution must be used when moving an appliance containing hot oil or other hot liquids.
13. If the plug gets hot, please call a qualified electrician.
14. Do not use this appliance for other than intended use.
15. Use extreme caution when removing the broiling tray or disposing of hot grease.
16. Do not clean with metal scouring pads. Pieces can break off the pad and touch electrical parts, creating a risk of electric shock.
17. To assure safe operation, oversized foods or utensils must not be inserted into the oven.
18. A fire may occur if this appliance is covered or touching flammable material, including curtains, draperies, walls, etc., when in operation.
19. CAUTION: Never leave the toaster-oven-broiler unattended when broiling and toasting.
20. When broiling, the bake/broil tray assembly and rack must be used.
21. Extreme caution should be exercised when using containers constructed of other than metal or glass.
22. Do not store any materials, other than the manufacturer's recommended accessories, in the oven when not in use.
23. Do not place any of the following materials in the oven: paper, cardboard, plastic and the like.
24. Do not cover any part of the oven with metal foil. This will cause overheating of the oven.
25. To switch off the toaster-oven-broiler, turn the ON/OFF knob to "OFF" and the cooking mode knob to "●".

THIS PRODUCT IS FOR HOUSEHOLD USE ONLY

SAVE THESE INSTRUCTIONS

NOTE: The oven may smoke during initial heat-up due to the oils used in manufacturing.

This is normal for a new appliance.

- If your product is equipped with a polarized alternating current line plug (a plug having one blade wider than the other). This plug will fit into the power outlet only one way. This is a safety feature. If you are unable to insert the plug fully into the outlet, try reversing the plug. If the plug should still fail to fit, contact your electrician to replace your obsolete outlet. Do not defeat the safety purpose of the polarized plug.
- Plug the cord into a 120 volt AC outlet.
- The cord length of this product has been selected to reduce the possibility of tangling in or tripping over a longer cord. If more cord length is needed, an extension cord may be used. It should be rated no less than 15 amps., 120 volts, and have Underwriters Laboratories/CSA listing.
- A six feet long, 15 amp. extension cord may be purchased from your local authorized service facility. When using a longer cord, be sure not to let it drape over the working area or dangle where someone could accidentally pull or trip over it.
- Handle the cord carefully for longer life; avoid jerking or straining the cord at the plug and appliance connections.

COOKING PROGRAMMES

The pilot lamp lights when the appliance is plugged into the mains. It does not mean that the oven has reached the selected temperature.

1) HOW TO KEEP FOOD WARM

Place the food to be kept warm on the wire rack (in position 1). Turn the upper knob to "ON". Turn the lower knob to "KEEP WARM". This feature is designed to keep foods warm, after they are cooked for short periods of time without overcooking. We do not recommend keeping foods warm for prolonged periods or using this feature to reheat frozen or cold foods.

2) INSTRUCTIONS FOR BAKING

You can bake foods in your oven, just as in your regular oven. Casseroles or baking dishes may be placed directly on the removable wire rack. Use the convenient bake/broil tray provided with your oven for baking such items as cookies, biscuits, rolls and uncovered casserole dishes. Place the bake/broil tray directly on the removable wire rack (position 2).

1. Close the door.
2. Set the lower knob to the desired position.
3. Turn the upper knob to "ON".
4. Both the bottom and top elements are on. However the primary heat comes from the bottom element.
5. When baking is finished turn the upper knob to "OFF" and the lower knob to position "●".

NOTE: We do not recommend the use of glass covers on casseroles. Glass cooking dishes should never be closer than one inch from the heating element.

HELPFUL BAKING HINTS

To obtain best performance from this toaster-oven-broiler:

- Do not overfill the oven. Whenever possible, place foods in center of oven.
- Avoid opening the door too frequently to prevent heat loss.
- Foil may be used to cover the baking dish or pan. Be sure the ends of foil are tucked closely against the edge of the baking dish/pan.

TOP BROWNING

Top Browning is ideal for melting, crisping and toasting food surfaces. Use it for open face sandwiches, pre-buttered muffins or browning cooked casseroles.

1. Place the food on the oven pan and place on the wire rack (position 2).
2. Close the door, set the lower knob to "BROIL" and the upper knob to "MEDIUM".
3. When experimenting with new uses, watch the food to avoid overbrowning. If necessary the browning cycle can be shortened by turning the upper knob to a lighter setting.
4. A ring indicates the end of the set time. The top browning cycle has been completed. The heating elements will shut off automatically.

3) INSTRUCTIONS FOR BROILING

Always use the bake/broil tray assembly with the removable wire oven rack for broiling. No preheating of the broiler is necessary.

Do not leave the broiler unattended when in use. Before using the broiler for the first time and after use, wash the tray and the rack with warm, sudsy water. Do not cover the bake/broil tray assembly or the oven wire rack with foil. This prevents fat and oils from draining, causing spatter and smoking, and also restricts air circulation for proper ventilation.

BROILING

1. Place the wire oven rack in the upper shelf position (position 3 or 4).
2. Position the aluminium drip pan directly on the lower heating element.
3. Place the food to be broiled on the wire rack.
4. Leave the oven door half open.
5. Turn the lower knob to "BROIL".
6. Turn the upper knob to "ON".
7. When broiling is finished, turn the upper knob to "OFF" and the lower knob to position "●". Care should be taken when removing the broiler pan and disposing of the grease collected while broiling.

NOTE: While smoke is an inherent characteristic of good broiling, the following tips should eliminate or greatly reduce smoking.

- Trim excess fat from meat and score the edges to prevent curling.
- For best results, thaw frozen meats before broiling. These two precautions will reduce or eliminate smoke from the broiler.
- Placing the food on the rack in the tray allows the juices and fat to drip into the tray and decreases spattering while broiling.
- If frozen steaks and chops are broiled, allow 1½ to 2 times the required broiling time as that required for unfrozen meat.
- If grease "pops" during broiling, turn the temperature control dial to a lower setting.
- Remove grease from the tray and wash the tray and rack after use.
- The broiler should be cleaned inside after each use. Too much grease accumulation causes smoking. Use any non-abrasive cleaner and hot water.
- For very thick steaks and other thick foods, we recommend using the lower shelf position.

4) DIRECTIONS FOR AUTOMATIC TOASTING

- For toasting, place the slices of bread as shown below:

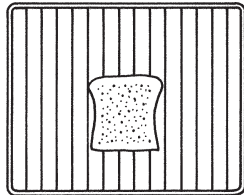

Toasting one slice

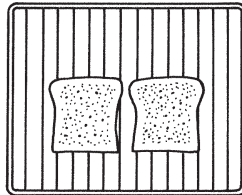

Toasting two slices

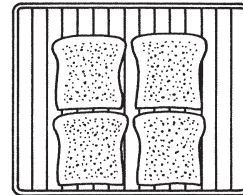

Toasting four slices

For consecutive toasting, turn the "TOAST START" dial to a lower setting.

INSTRUCTIONS FOR TOASTING

Always use the oven wire rack for toasting bread, sandwiches, English muffins, shelf foods and frozen waffles automatically.

1. Place the wire rack in upper shelf position (position 5 for toast, or position 6 for toasted sandwiches).
2. Center the food to be toasted on the wire rack. Close the door.
3. Turn the lower knob to "TOAST". When toasting, both the top and bottom heating elements switch on to brown both sides of the food at the same time.
Condensation may build up on the inside of the glass door. This is normal. The condensation will evaporate during the toasting cycle.
4. Set the upper knob to the desired brownness.
When using the toaster-oven-broiler for the first time, set the upper knob to a medium setting. Toast a few pieces of bread to check for desired brownness. If necessary, adjust the control to suit your preference.
5. A ring indicates the end of the set time. The toasting cycle has been completed and the heating elements will shut off automatically.

NOTE: This toaster-oven-broiler is capable of toasting in a wide range of colours, automatically from light to dark. However, if you prefer a lighter shade of toast, simply interrupt the automatic toast cycle by turning the upper knob to "OFF". This will shut the unit off without damaging the oven.

If you prefer a darker shade, restart the toasting cycle by turning the upper knob clockwise until the desired colour is obtained.

Then switch off manually as described earlier.

HINTS FOR TOASTING SUCCESS

Heavier breads and frozen breads will require a darker setting. One slice of bread will require a lighter setting than several slices.

5) COOKING PIZZA

1. Place the wire oven rack in the lower position and place the special pizza stone on the rack (position 7).
2. Turn the upper knob to "ON".
3. Set the lower knob to 450°F and pre-heat the oven for 5 - 7 minutes.
4. Place the pizza on the pizza stone.
5. Close the oven door. After about 10 minutes, turn the selector to "PIZZA" and leave it in this position until the pizza is cooked (about 8 minutes).
6. When the pizza is cooked, turn the upper knob back to "OFF" and then turn the lower knob to position "●".

CLEANING

PERIODIC CLEANING OF THE CONTINUOUS-CLEANING OVEN AREAS

Due to excessive spattering or food touching the continuous-cleaning finish, some residue may not be removed by the continuous-cleaning process.

Always unplug the toaster-oven-broiler and allow it to cool before cleaning.

1. The surface may be cleaned using a nylon pad and a mild liquid soap solution.
2. Never use harsh abrasives, caustic cleaners or oven cleaners on the continuous-clean surface.
3. The oven rack, door, and the top and bottom of the oven must be cleaned by hand.

CLEANING OTHER PARTS OF THE OVEN

Always unplug the oven and allow it to cool before cleaning. This unit has been designed and engineered with your safety in mind. To assure maximum safe operation, keep unit clean free of grease and build-up of food particles.

1. Remove the wire oven rack.
2. To clean the glass door, use a glass cleaner or a damp cloth. Wipe dry with a clean cloth.
3. Clean the oven floor after use to avoid build-up of residue, as this will affect the cooking performance. Brush off crumbs or wipe the oven floor with a damp cloth. For stubborn stains, use a nylon or plastic scouring pad or a powdered, non-caustic cleaner. Dry thoroughly before closing.
4. To clean the exterior finish, use a damp, sudsy cloth. For stubborn stains, a non-abrasive liquid cleaner or spray glass cleaner may be used. Do not use metal scouring pads, as they might mar the finish. Always remove cleaning agents by polishing with a dry cloth.

NOTE: Do not clean interior with metal scouring pads. Pieces can break off and touch electrical parts, creating risk of electrical shock.

CLEANING THE BOTTOM OF THE OVEN

To clean the bottom of the oven, open the access panel by pressing the latch spring (see fig.A/B). Place the oven on its rear panel. This will make cleaning easier.

After cleaning, close the access panel and check that it is locked securely into position.

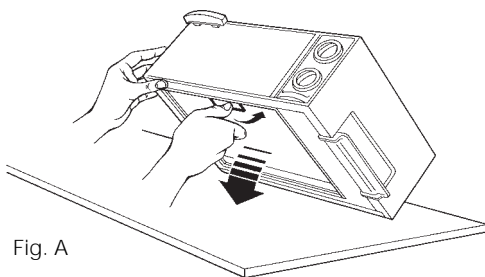

Fig. A

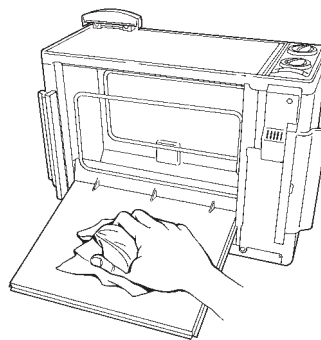

Fig. B

CLEANING THE PIZZA STONE

1. Do not use oils or fats when cooking with the pizza stone.
2. Cooking residue can be removed using a spatula or a knife. For more thorough cleaning, heat the pizza stone in the oven and clean with an abrasive pad and rinse in hot water.
3. After a time, the pizza stone may darken. However, this will not affect its characteristics.

OTHER SERVICING

Any servicing requiring disassembly should be performed by an authorized service representative.

Limited Warranty

What Does This Warranty Cover? We warrant each appliance to be free from defects in material and workmanship. Our obligation under this warranty is limited to replacement or repair, free of charge at our factory or authorized service centers, of any defective part or parts thereof other than parts damaged in transit, which shall be returned to us, transportation prepaid. This warranty shall apply only if the appliance is used in accordance with the factory directions which accompany it, and on an Alternating Current (AC) circuit.

How Long Does The Coverage Last? This warranty runs for one year from the date of delivery and applies only to the original purchaser for use.

What Does This Warranty Not Cover? This warranty does not cover defects or damage of the appliance which result from repairs or alterations to the appliance outside our factory or authorized service centers, nor shall it apply to any appliance which has been subject to abuse, misuse, negligence or accidents. Also, consequential and incidental damages resulting from the use of this product or arising out of any breach of contract or breach of this warranty are not recoverable under this warranty. Some states do not allow the exclusion or limitation of incidental or consequential damages, so the above limitation may not apply to you.

How Do You Get Service? If repairs become necessary or spare parts are needed, please write to:

De' Longhi America Inc.
625, Washington Avenue
Carlstadt N.J. 07072
or call Service Tel. No. 1-800-322-3848

The above warranty is in lieu of all other express warranties and representations. All implied warranties are limited to the applicable warranty period set forth above. This limitation does apply if you enter into an extended warranty with De' Longhi. Some states do not allow limitations on how long an implied warranty lasts, so the above exclusions may not apply to you. De' Longhi does not authorize any other person or company to assume for it any liability in connection with the sale or use of its appliance.

How Does State Law Apply? This warranty gives you specific legal rights, and you may also have other rights which vary from state to state.

FOR U.S. ONLY:

✂

IMPORTANT!
PLEASE COMPLETE THIS CARD AND RETURN WITHIN THE NEXT 10 DAYS TO
ESTABLISH PROPER REGISTRATION OF YOUR NEW DE' LONGHI PRODUCT

Mr. Mrs. Miss _____

Street _____

City _____ State _____ ZIP _____

Ph. _____ Marital status: Single Married Divorced

Date of Purchase: Month _____ Day _____ Year _____

DE' LONGHI Model: Purchased from _____

This product was a planned purchase gift impulse purchase

The product was selected by Male Female Both

Selection of this product was prompted by:

<input type="checkbox"/> Advertising	<input type="checkbox"/> Appearance	<input type="checkbox"/> In store display
<input type="checkbox"/> Brand Name	<input type="checkbox"/> Features	<input type="checkbox"/> Previous ownership
<input type="checkbox"/> Price	<input type="checkbox"/> Referral	<input type="checkbox"/> Packaging

Age group 16-24 25-34 35-44 45 and over

Type of residence house apartment other

Room where the product will be used _____

PLACE
STAMP
HERE

DE' LONGHI AMERICA, INC.
625 WASHINGTON AVENUE
CARLSTADT, N.J. 07072

ATTN. CONSUMER RELATIONS MANAGER